

## EXO 24CHA4

EXO-series plug-in output relay for hazardous locations

### Main features

- Solid state output relay for hazardous locations
- Non-sparking device, type of protection nA
- cULus Listed HazLoc, ATEX, IECEx, CE (EMC and LVD)
- Integrated status LED
- For resistive and inductive loads

### Functional block diagram

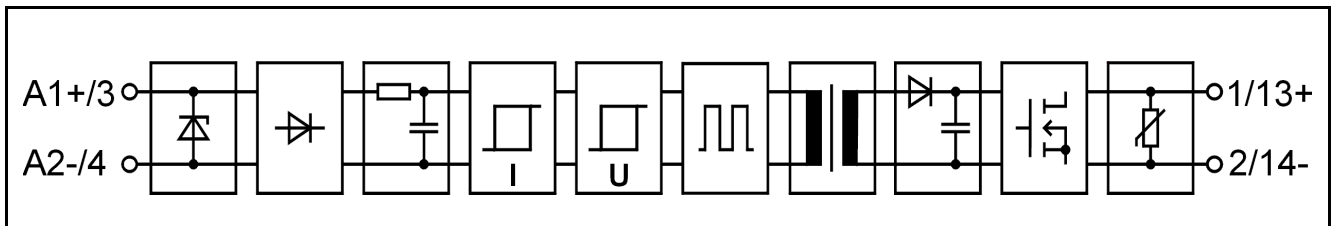

### Main specifications

Breakdown voltage I/O	minimum	4600	VAC rms
Air/creepage distances I/O	minimum	8	mm
Capacitance I/O	typical	3	pF
Material of the casing	PBT	UL 94V-0 (Sabic Innovative Plastics, Valox 420SEO)	
Colour of the casing	Gray		
Weight	typical	40	g
Temperature range:			
Storage	range	-40...+70	°C
Operation	range	-40...+70	°C

### Electrical specifications ( $T_A = 25\text{ °C}$ )

Primary				Secondary			
Input voltage	nominal	28	VDC	Load voltage	nominal	250	VDC
Input current at nominal voltage	typical	12	mA	Load current	maximum	4	A
	maximum	15	mA	Load current	maximum	20	A (10 ms)
Switch-on voltage	typical	16	VDC	Voltage drop at 4 A	typical	0,6	V
	maximum	18*	VDC	Switch-on delay	typical	0,3	ms
Switch-off voltage	typical	14	VDC		maximum	0,5	ms
	minimum	12	VDC	Switch-off delay	typical	0,3	ms
					maximum	0,5	ms
				Inductive load, L/R	maximum	5	ms (250 V, 4 A)
					maximum	50	ms (24 V, 4 A)
				Leakage current (off-state)	maximum	1	mA

Ambient temperature ( $T_A$ ) means the temperature immediate in vicinity of relays, where the air flow meets the relays.

\*In -40°C ambient the maximum switch-on voltage may rise to 20VDC.

## Deratings

Allowed load is derated to 1/3 linearly from +30 °C to +70 °C ambient temperature. When relays are mounted together as a bank, there should be a gap in both sides at least 12,5 mm. In side by side assembly the load current should be restricted to 50 % of the maximum current. These deratings apply to the horizontal rail assembly and also in vertical rail assembly.

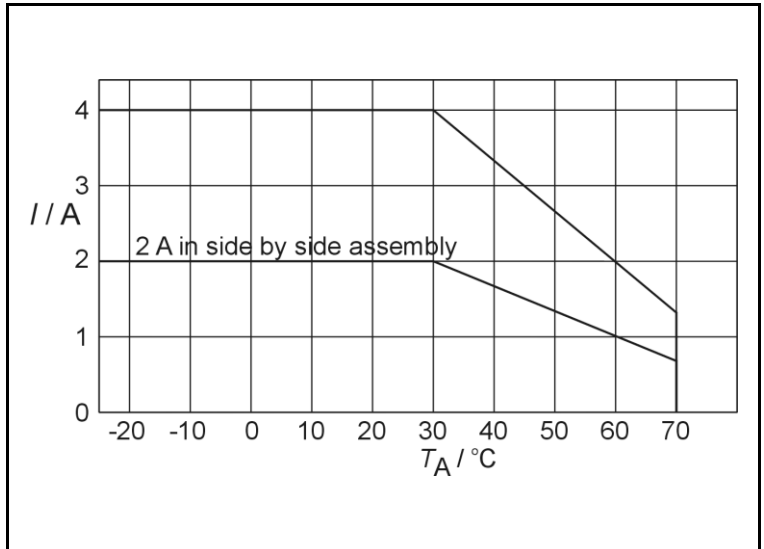

## Derating when switching inductive loads

This relay is meant for resistive and inductive loads. The surge current is not allowed to exceed the specification. For reasons of heat dissipation, when the load will be switched frequently, the average current over a reasonable time should not exceed the specification for continuous operation.

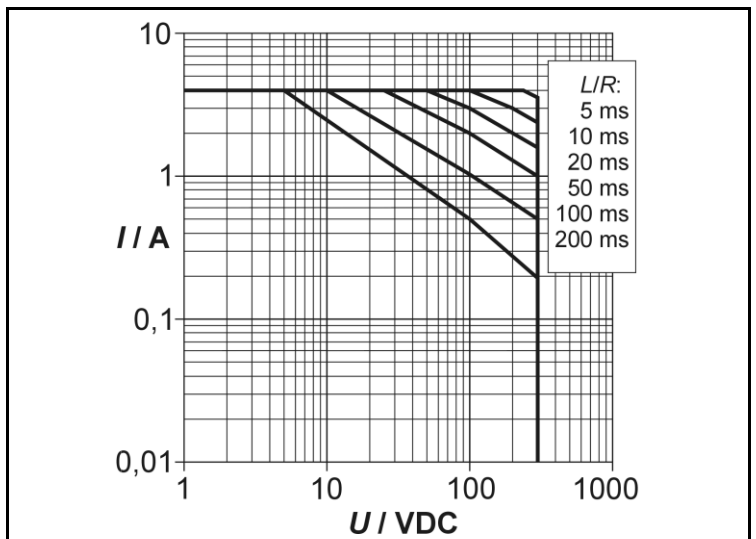

## Fusing

To protect relay against short circuit and overload a fast fuse with the correct rating for the load and the capacity of the relay should be chosen. Note that when overload current is not large it is possible that the fuse will not protect the relay because of the tolerance on the fuse rating.

## Hazardous area installation

The Solid State Relays shall be installed in accordance with the ATEX directive 2014/34/EU and this specification. The relay shall be installed within a suitable Ex-certified enclosure providing protection from impact, light, solid foreign objects and water ingress to a level of at least IP54. The relay shall be derated in accordance with this specification.

The relay shall only be installed to mounting sockets MOS 1EX, MOS 1NEX, MOS 1GEX, MOS 1GNEX, MOS 1CCEX, MOS 1CCNEX, MOS 1TEX and MOS 1TNEX. Fixing with the captive screw. The recommended installation is to the horizontal rail for better cooling of the relays.

### Assembling in non-hazardous locations

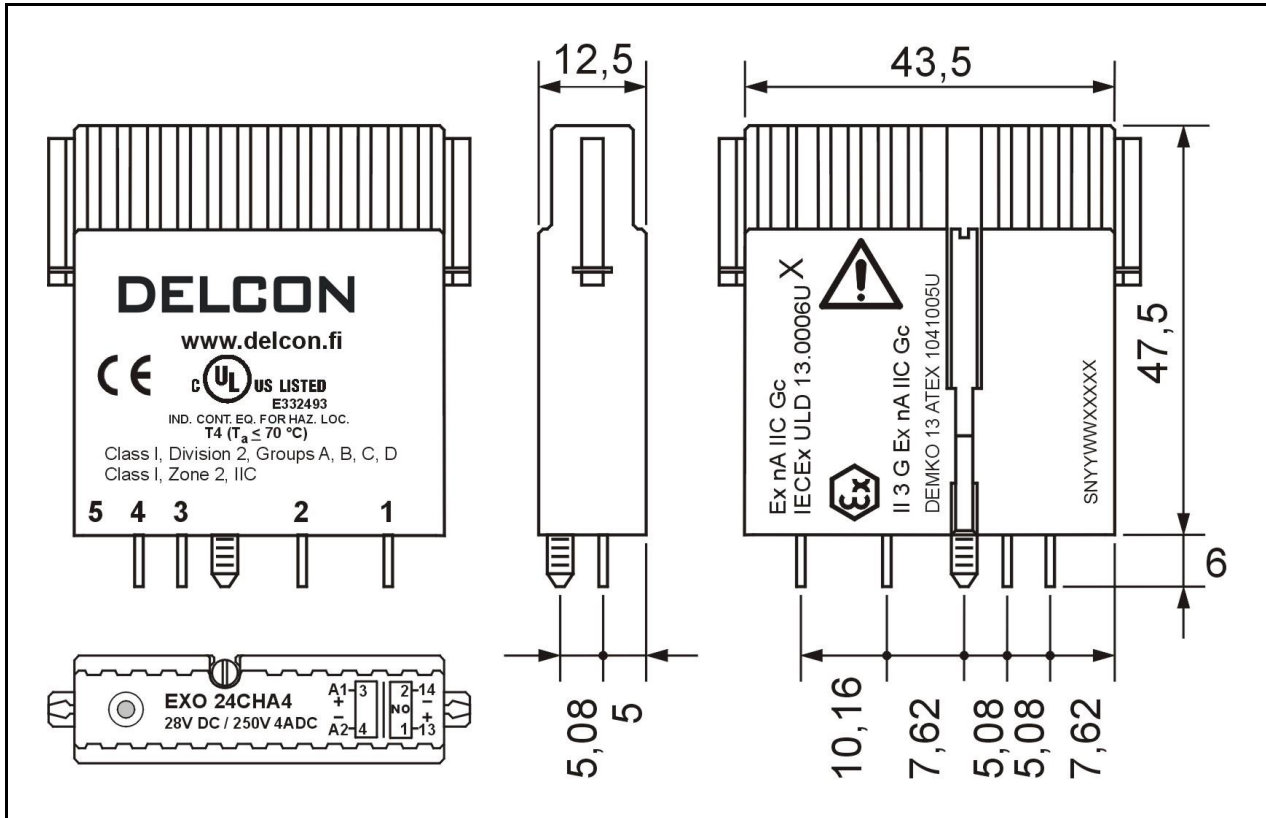

All MOS 1... -mounting sockets, all MB/MBS 8/16... -mounting bases. See the assembly instructions from SL-relay specifications.

### Mechanical dimensions



EXI 24CHA4 (dimensions in mm, nominal). Markings can be located differently by production lot. Production lot number is marked to the relay (SN = serial number YY = year, WW = week, XXXXX = lot number).

### Approvals

 IND. CONT. EQ. FOR HAZ. LOC.	Class I, Division 2, Groups A, B, C, D Class I, Zone 2, IIC (when assembled to Ex-approved Delcon mounting socket) Certificate: E332493
<b>ATEX</b>	 <b>II 3G Ex nA IIC Gc</b> (when assembled to Ex-approved Delcon mounting socket) Certificate: DEMKO 13 ATEX 1041005U
<b>IECEX</b>	<b>Ex nA IIC Gc</b> (when assembled to Ex-approved Delcon mounting socket) Certificate: IECEX ULD 13.0006U
	Fulfils main requirements of the EMC-directive 2014/30/EU. Fulfils requirements of the low voltage directive (LVD) 2014/35/EU.

## Standards for Ex-approvals:

IEC 60079-0:2019- Explosive atmospheres - Part 0: Equipment - General requirements

IEC 60079-15:2019:en Electrical apparatus for explosive gas atmospheres. Part 15: Construction, test and Marking of Type of Protection "n" electrical apparatus

CENELEC EN 60079-0 1 July 2018 Explosive atmospheres - Part 0: Equipment - General requirements

CENELEC EN 60079-15 1 April 2019 Explosive atmospheres - Part 15: Equipment protection by type of protection "n"

CSA C22.2 NO 213 - NON-INCENDIVE ELECTRICAL EQUIPMENT FOR USE IN CLASS I, DIVISION 2 HAZARDOUS LOCATIONS 3rd Edition, April 2021

ANSI/ISA-12.12.01-2015 CAN/CSA C22.2 NO. 213-15, Nonincendive Electrical Equipment for Use in Class I and II, Division 2 and Class III, Divisions 1 and 2 Hazardous (Classified) Locations

## Guarantee

This Ex -solid state I/O relay type made by Delcon Oy is guaranteed free from design and manufacturing defects for a period of 10 years from the manufacturing date. The guarantee liability is limited to replacement of defective material and related shipping charges. Defective products must be returned to the manufacturer for evaluation. This guarantee does not cover damage due to incorrect use or electrical overload.