



SLO12CRX

Plug-in relay for DC-loads

1 N/O contact (solid state, MOSFET)

Main data

Nominal load voltage	24 V DC
Nominal input voltage	12 V DC
Rated load current	8,3 A
MTTF (MIL-HDBK-217F)	256 years
Warranty	10 years

Control circuit

Input voltage max.	18 V DC
Switch-on voltage	8 V DC
Switch-off voltage	7 V DC
Power consumption	108 mW
Input impedance	1,3 kΩ

Load circuit

Load current range	0 - 8,3 A, no minimum load required
Load voltage range	0 - 32 V DC, no minimum load required
Inrush current	80 A, 10 ms
Leakage current	1 mA
Voltage drop	0,3 V
Max. inductive load, L/R	2 ms (24 V / 5 A)
Switch-on time	0,3 ms
Switch-off time	0,3 ms

Insulation

Insulation method	Pulse transformer (an unique feature for Delcon relay compared to opto)
Test voltage input/output	4600 V AC _{rms} / 1 s
Overtoltage category	III
Pollution degree	2
Air/creepage distance I/O	8 mm

General data

Conductor size, screw terminal	2,5 mm ²
Conductor size, spring terminal	0,75 - 2,5 mm ²
Operating temperature	-40 °C to +70 °C
Weight	40 g
Housing material flammability	UL 94 V-0
Package size	10, 50 and 100

Additional features



Delcon uses a pulse transformer instead of optocoupler for transmission of the signal from the primary to the secondary side and to provide 4600 VAC galvanic isolation between the field and controller side of the relay.

This design is radically different from optocoupler relays and modules in which the energy for the switching circuit is taken from the load circuit, which leads to many drawbacks such as minimum load requirement, leakage current and sensitivity to load line spikes.



Suppression circuits and both voltage and current hysteresis on a signal sides to ensure that they work correctly in industrial areas with high interference levels originated by cable capacitance



Built-in protection (varistor, diode, RC-circuit etc. depended on the relay type) for the switching component to extend reliability and life time even more

Standard accessories

DIN-rail base, screw terminals	MOS1GN
DIN-rail base, tension clamp	MOS1CCN
Bus bar for bridging, 4-pole	Jumper 4-13
Bus bar for bridging, 8-pole	Jumper 8-13
Bus bar for bridging, 16-pole	Jumper 16-13

Dimensions



Approvals, conformities



Fulfills main requirements of the EMC-directive **2014/30/EU** and low voltage directive (LVD) **2014/35/EU**. The relay has been designed to operate correctly with difficult loads in disturbed environments. Thus, it does not meet the conducted emission for 150 kHz...2 MHz.



UL certificate 20161220-E162828, Power Conversion Equipment, UL508 & CAN/CSA C22.2 No. 14-10

Derating

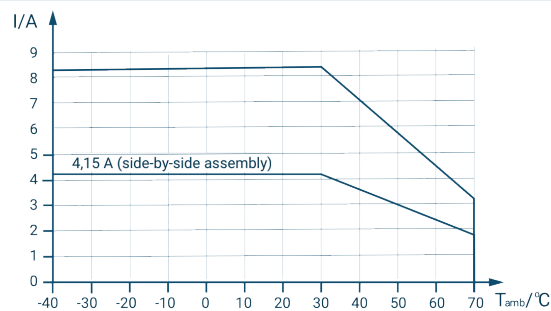

Allowed load is derated to 1/3 linearly from +30 °C to +70 °C ambient temperature. When relays are mounted together as a bank the maximum load current for long period of time should be restricted in total to 50 % of the current from the curve. I.e. all relays at 50 % load continuously or 50 % of the relays at 100 % load continuously or all relays at 100 % load 50 % of the time. This restriction does not apply if there is at least 12,5 mm gap between relays. These deratings apply when assembled to the horizontal rail. If assembled to the vertical rail, must be taken care that the relays do not heat up too much.

Wiring diagram



Derating when switching inductive loads

This relay is meant for resistive and slightly inductive loads. A clamp diode with the load must be used when switching inductive loads. The surge current is not allowed to exceed the specification. For reasons of heat dissipation, when the load will be switched frequently, the average current over a reasonable time should not

Assembly

Long lifetime and our 10 year guarantee requires that proper cooling of the relays is ensured. Therefore, all relays with MOS 1*** DIN-rail sockets and all MBS 8/16*** mounting bases are strongly recommended to be installed to the horizontal rail.

Guarantee

This solid state I/O relay type made by Delcon Oy is guaranteed free from design and manufacturing defects for a period of 10 years from the manufacturing date. The guarantee liability is limited to replacement of defective material and related shipping charges. Defective products must be returned to the manufacturer for evaluation. This guarantee does not cover damage due to incorrect use or electrical overload.



Fusing

To protect relay against short circuit and overload a fast fuse with the correct rating for the load and the capacity of the relay should be chosen. Note that when overload current is not large it is possible that the fuse will not protect the relay because of the tolerance on the fuse rating.

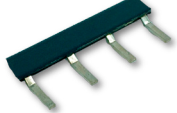
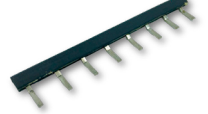

Din-rail sockets

- 
MOS1GN for SLO*** relays, screw terminals
- 
MOS1CCN for SLO*** relays, spring terminals
- 
MIS1GN for SLI*** relays, screw terminals
- 
MIS1CCN for SLI*** relays, spring terminals
- 
MOS1CO for SLO24COA change-over relay, screw terminals

Bus bars

- 
Jumper 2-13 Bus bar for bridging, 2-pole
- 
Jumper 4-13 Bus bar for bridging, 4-pole
- 
Jumper 8-13 Bus bar for bridging, 8-pole
- 
Jumper 16-13 Bus bar for bridging, 16-pole

PCB sockets

- 
PCO1N PCB socket for SLO***-relays
- 
PCI1N PCB socket for SLI***-relays
- 
PCU1N PCB socket for SL****-relays

PLC Fast Connect™

PLC Fast Connect™ is an easy and fast way to connect 8 or 16 relays at the time to the PLC together with adequate **MBS**-mounting base and connecting cable. There are 3 ways to make a fast and reliable connection:

1. Assemble 8 or 16 relays on the adequate **MBS**-mounting base. Then connect other end of either **RC10X-xxx** or **RC20X-xxx** cable to the base with matching connectors and the other end wire-by-wire to the PLC.
2. Select an adapter suited for your PLC's I/O-card and assemble it. Then assemble 8 or 16 relays on the adequate **MBS**-mounting base and connect other end of either **RC10-xxx** or **RC20-xxx** cable to the base with matching connectors and the other end to the adapter likewise matching connector.
3. Assemble 8 relays on the adequate **MBS**-mounting base and connect other end of **RC10-xxx S7-1500** cable to the base with matching connector and the other end to the front connector's likewise matching connector (Siemens S7-1500).

NOTE! If you can't find matching adapter or cable, please contact sales@delcon.fi. We have additional adapters on the way and new ones can be made in relatively short notice.

Example 1

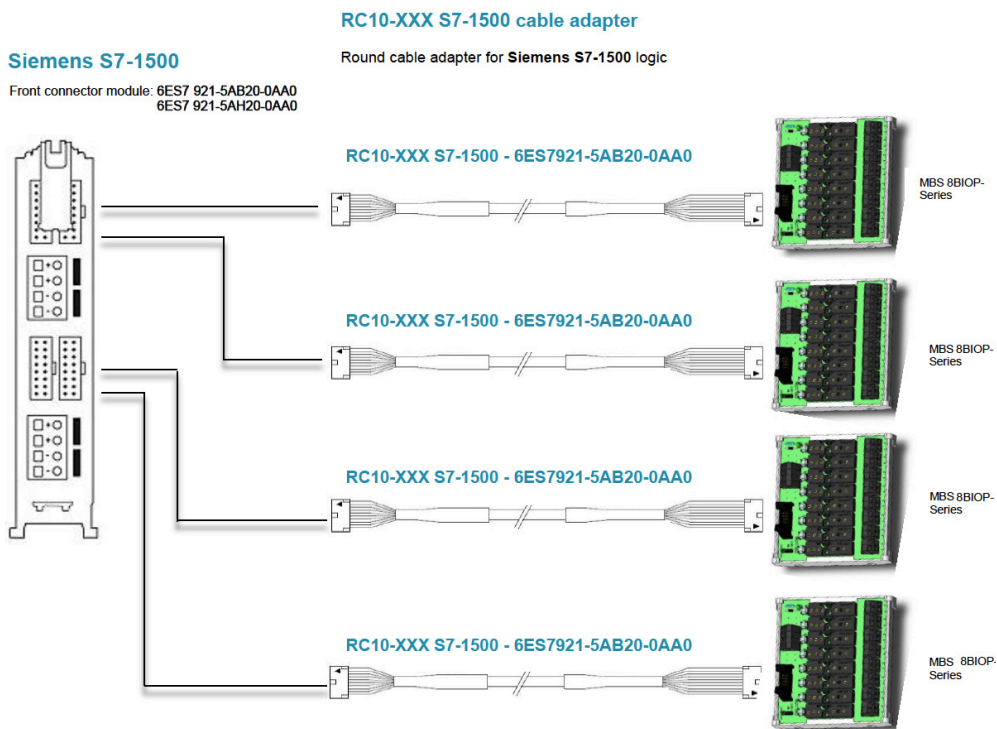

Example 2

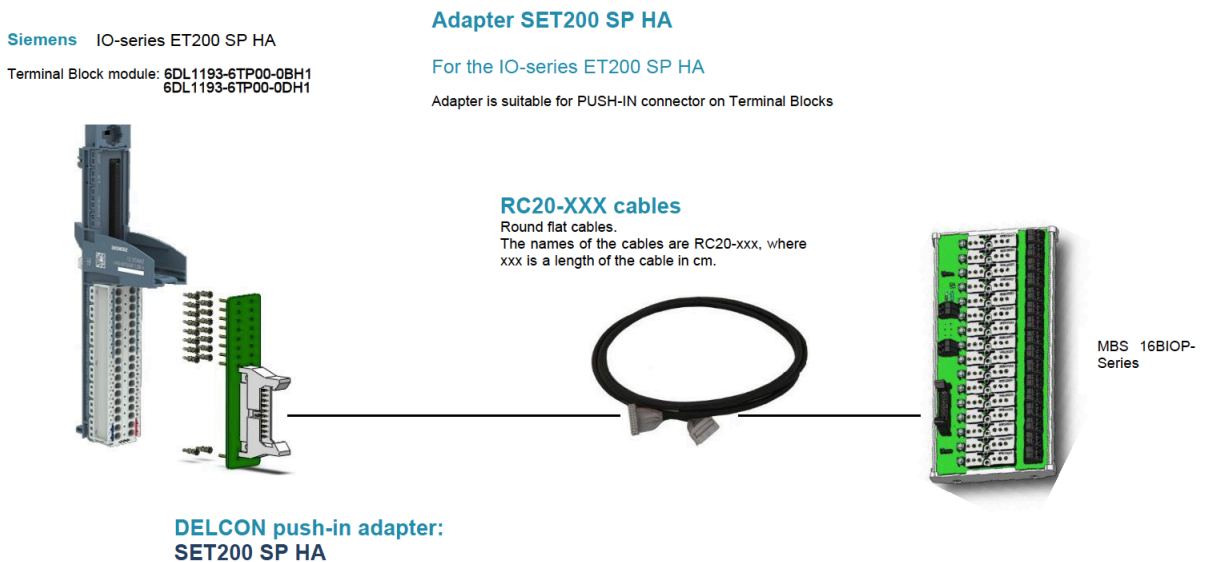

PLC Fast Connect™ mounting bases for relays



MBS8BIOP for 8 relays, screw terminals



MBS8BIOPCC for 8 relays, spring terminals



MBS16BIOP for 16 relays, screw terminals



MBS16BIOPCC for 16 relays, spring terminals

PLC Fast Connect™ cables



RC10X-xxx

10-pole round cable (xxx = length / cm, in 50 cm steps)
Connection to PLC with colour coded single wires with ferrules



RC20X-xxx

20-pole round cable (xxx = length / cm, in 50 cm steps)
Connection to PLC with colour coded single wires with ferrules



RC10-xxx

10-pole round cable (xxx = length / cm, in 50 cm steps)
Connection to the PLC with applicable PLC Fast Connect™ adapter



RC20-xxx

20-pole round cable (xxx = length / cm, in 50 cm steps)
Connection to the PLC with applicable PLC Fast Connect™ adapter

PLC Fast Connect™ adapters and converters

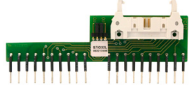

S7I032L

PLC adapter for Siemens Simatic S7-300 -logic, 16-channels, **LEFT**

Front connector: 6ES7 392-1AM00-0AA0
Input unit: 6ES7 321-1BL00-0AA0
Output unit: 6ES7 322-1BL00-0AA0



S7I032R

PLC adapter for Siemens Simatic S7-300 -logic, 16-channels, **RIGHT**

Front connector: 6ES7 392-1AM00-0AA0
Input unit: 6ES7 321-1BL00-0AA0
Output unit: 6ES7 322-1BL00-0AA0



S300IO16

PLC adapter for Siemens Simatic S7-300 -logic, 16-channels

Front connector: 6ES7 392-1AJ00-0AA0
Input units: 6ES7 321-1BH01-0AA0, ES7 321-1BH01-0AA0
Output unit: 6ES7 322-1BL00-0AA0

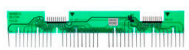

S400IO32

PLC adapter for Siemens Simatic S7-400 -logic, 32-channels

Front connector: 6ES7 492-1AL00-0AA0



FCA16N/P
FCA16N/P-2
FCA16P/N

NPN to PNP Converter 16 Channels
NPN to PNP Converter 16 Channels 2 wire
PNP to NPN Converter 16 Channels



RC10-xxx S7-1500

Round cable adapter for Siemens S7-1500-logic

Front connectors: 6ES7 492-1AL00-0AA0, 6ES7 492-1AH00-0AA0



SET200 SP HA

Adapter for Siemens IO series ET200 SP HA, mounts in push-in connector on the terminal block

Terminal Block modules: 6DL1193-6TP00-0BH1, 6DL1193-6TP00-0DH1

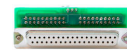

M82IO/M82IO2.5

PLC adapter for Mitsubishi Melsec-logic. M82IO with 3 mm screws. M82IO2.5 with 2,5 mm screws

Input unit: QX81
Output unit: QY81P



TU810IO16

PLC adapter for ABB PLC S800 / unit TU810

Input unit: DI810
Output unit: DO810



RCTU812-xxx

Cable adapter with 25-pole D-subconnector for ABB PLC S800 / unit TU812

Input unit: DI810
Output unit: DO810P